

B (Flap position detector)

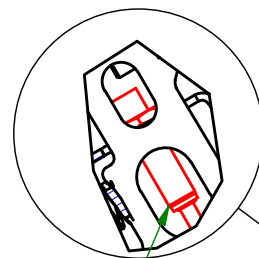

Inductive detector M12

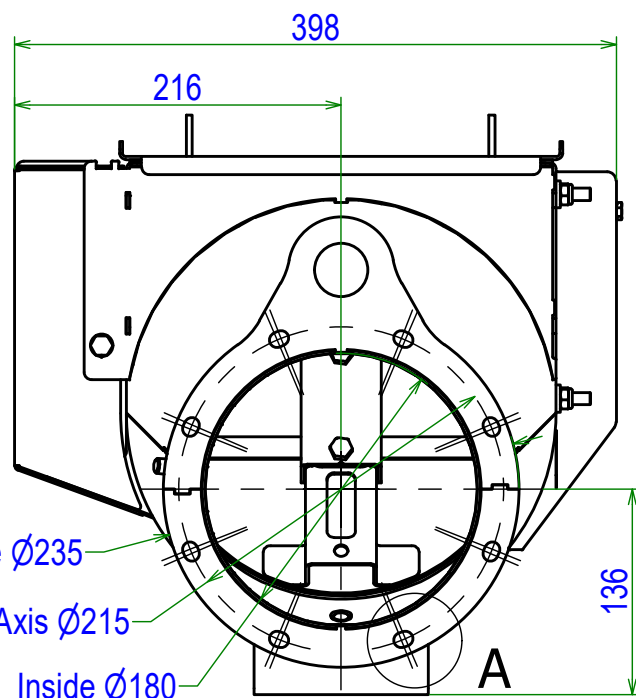

C (Build up detector)

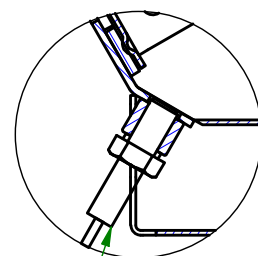

Capacitive detector M12

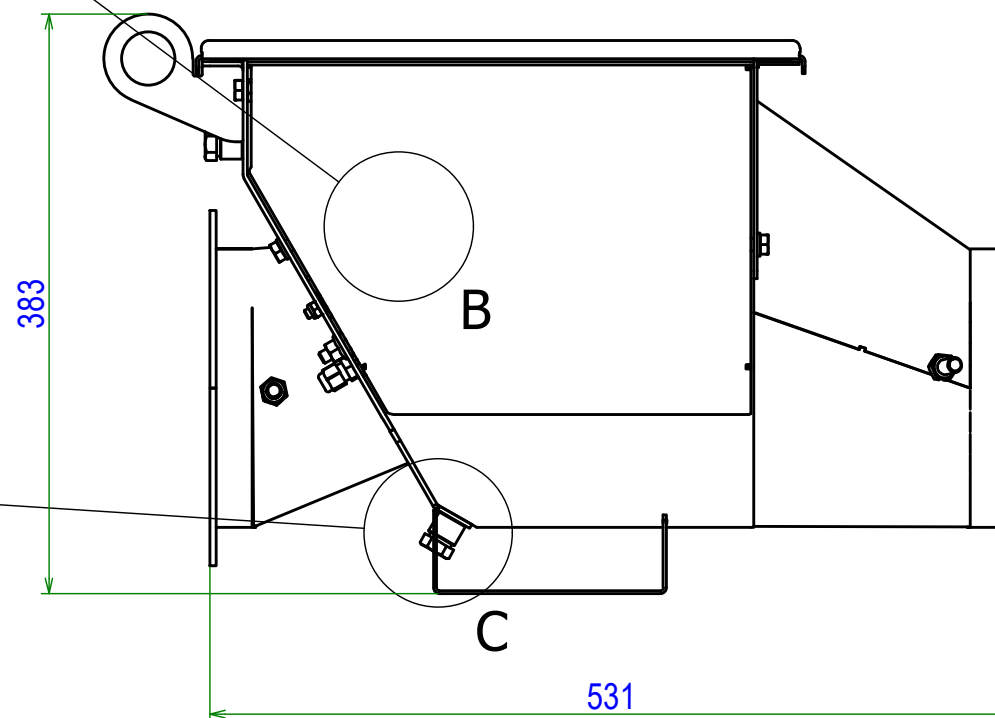

A (Hole x8 for M8 screw)

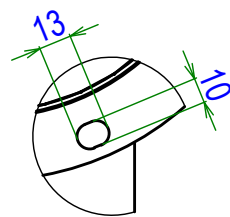

Pressure resistance = 2bar
Optional flanges and flange gaskets

Informative dimension

Weight : 19 kg

A	Création	19/03/21	BM	MJ
Ind.	Objet de la modification	Date	Nom	Vérif.
Matière:		Date de création: 19/03/2021	A3	Ech.: s/e
Plan n°: 57VP_018_Clt				
Désignation: VigiFlap PASSIVE Ø180				